

POMPE AUTOADESCANTI

SELF-PRIMING PUMPS

SUPERJET 100



SUPERJET 150-300



 Pompe autoadescenti ideali per impianti domestici e industriali, per lavaggi con getti e giardinaggio. Robusta costruzione. Alto rendimento. Sicurezza di funzionamento. Portate elevate. Servizio continuo. Aspirazione fino a 9 metri.

Corpo pompa e supporto in ghisa. Girante in ottone. Tenuta meccanica in ceramica/grafite. Motore chiuso autoventilato. Albero in acciaio inox AISI 416.

Tensione monofase con protezione termica incorporata; tensione trifase con protezione a cura dell'utente.

IP 44 sul modello SUPERJET 100, IP 55 sui modelli superiori. Isolamento classe F. Temperatura massima dell'acqua 50 °C.

 Self-priming pumps suitable for domestic and industrial plants, for gardening, for washing with water jet. Heavy duty construction. High performance. High deliveries. Continuous service. Suction head up to 9 metres depth.

Pump body and pump support in cast iron. Impeller in brass. Mechanical seal in ceramic/carbon. Closed self-ventilated motor. Shaft in stainless steel AISI 416.

Single-phase voltage pumps with built-in motor protector. The three-phase voltage pumps must be protected by a fused remote isolator switch.

IP 44 on model SUPERJET 100, IP 55 on other models. Insulation class F. Max. water temperature 122 °F (50 °C).

 Pompes autoamorçantes indiquées pour la distribution d'eau dans les installations domestiques et industrielles, pour lavages à jet d'eau, pour arrosage, etc. Construction robuste. Rendement élevé. Sécurité de fonctionnement. Débits élevés. Aspiration jusqu'à 9 mètres de profondeur.

Corps de pompe et support en fonte. Roue en laiton. Garniture mécanique en céramique/graphite. Moteur enfermé avec ventilation extérieure. Arbre en acier inox AISI 416.

Bobinage monophasé avec protection thermique incorporée; bobinage triphasé avec protection par l'utilisateur.

IP 44 sur le modèle SUPERJET 100; IP 55 sur les autres modèles. Isolation classe F. Température max. de l'eau 50 °C.

 Selbstansaugende Pumpen zur Hauswasserversorgung, zur Bewässerung usw.

Die Pumpen sind aus hochwertigen Materialien hergestellt und haben eine sehr hohe Förderleistung. Manometrische Saughöhe bis zu 9 Meter.

Pumpengehäuse aus Grauguß. Laufrad aus Messing. Keramik/Graphit Gleitringdichtung. Antriebswelle aus rostfreiem Stahl AISI 416.

Einphasenspannung mit thermischen Motorschutz; Dreiphasenspannung mit Motorvollschutz nach Benutzersorge.

IP 44 Schutz beim Modell SUPERJET 100, IP 55 Schutz bei allen anderen Modellen.

Isol. Klasse F. Max Temperatur der Flüssigkeit: 50 °C.

Modello Model Modèle Modell	Potenza Power Puissance Pferdestärke		Tensione Voltage Bobinage Spannung	A	Portata - Capacity - Débit - Fördermenge (l/min)									
	HP	kW			Prevalenza - Head - Hauteur - Förderhöhe (m)									
					0	20	40	60	80	100	120	140		
SUPERJET 100	1	0,75	230/50/1	4,5	43	36	24	3						
SUPERJET 150	1,5	1,1	230/50/1	8,5	50	46	40	35	28	20	11			
			230-400/50/3	8,0-4,6										
SUPERJET 200	2	1,5	230/50/1	9,4	56	52	47	42	35	28	19			
			230-400/50/3	8,5-4,9										
SUPERJET 300	3	2,2	230/50/1	11,9	62	57	53	48	42	35	26	15		
			230-400/50/3	8,7-5,0										

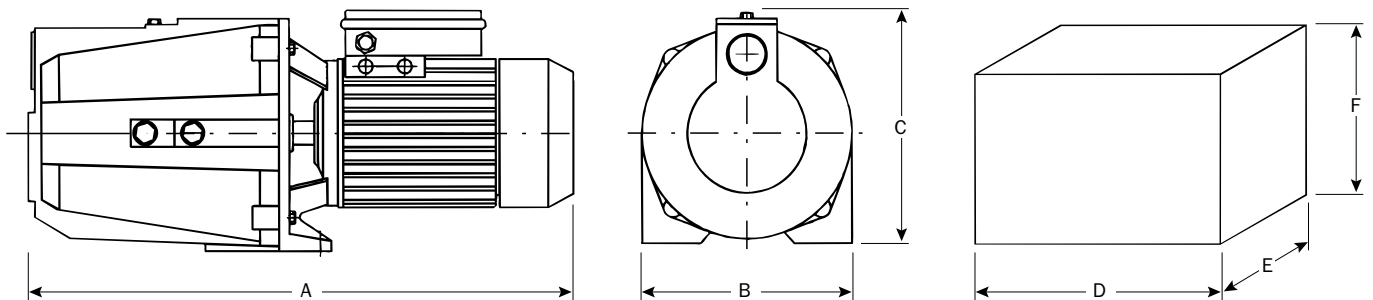
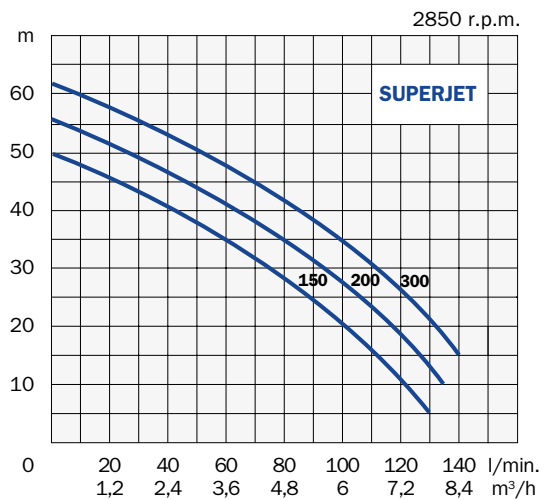
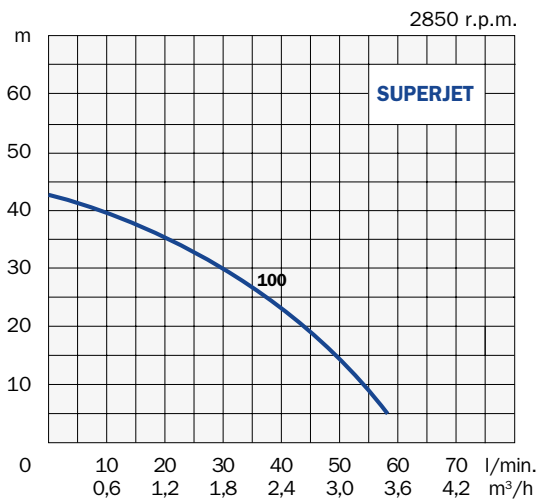

Modello Model Modèle Modell	Aspirazione Suction Aspiration Saug-Seite	Mandata Discharge Refoulement Druck-Seite	Dimensioni - Dimensions - Masstabelle						Peso Weight Poids Gewicht
			mm						
			A	B	C	D	E	F	
SUPERJET 100	1" - DN 25	1" - DN 25	425	185	200	440	220	240	17
SUPERJET 150	1"1/2 - DN 40	1"1/4 - DN 32	555	221	242	600	260	275	32
SUPERJET 200	1"1/2 - DN 40	1"1/4 - DN 32	555	221	242	600	260	275	33
SUPERJET 300	1"1/2 - DN 40	1"1/4 - DN 32	555	221	242	600	260	275	34